

QSI GREASE ARRESTOR

Made from polyethylene.

Used to pre-treat waste tradewaste prior to discharge to sewer.

Sizing

Grease Arrestor litre size 1000 1500 2000 3000 4000 5000
Flow litres per working day 1000 3200 6400 9600 12800 16000
Maximum seating capacity 69 199 399 500 799 1000

1.0 General summary - refer to manual for full detail.

- 1.1 Install in a location that will not interfere with or obstruct fire access or be vandalised or damaged by vehicles.
- 1.2 Install bollards or vandal proof cage if necessary.
- 1.3 Ensure easy access to the pump out point is maintained.
- 1.4 To service & maintain, install a cold water hose tap within 5 metres
- 1.5 Fit hose tap with an RPZD back flow protection (as per AS/NZS 3500).
- 1.6 Fit an RPZD to Water Authority boundary meter

2.0 Above ground installations

- 2.1 Support tank on a 100mm thick concrete pad
- 2.2 Install maintenance platform to service in accordance with AS 1657-1992.
- 2.3 Support pipework so no load is placed on tank connections.
- 2.4 Divert Stormwater away from tank to prevent undermining foundation.

3.0 Installation below Ground

- 3.1 Connections to the arrestor to be in accordance with appropriate authorities.
- 3.2 Fill the tank with water prior to backfill to test for leaks and to settle tank.
- 3.2 Excavations greater than 1.5m to be in accordance with Construction Safety Act.
- 3.3 Allow height of base, tank, flanges and access cover and excavate to depth.
- 3.4 Allow 75mm clearance to side excavation only.
- 3.4 Install anti floatation rods to tank legs prior to lowering to position.
- 3.5 If depth is over excavated fill with bedding material to achieve 98% compaction or concrete.

4.0 Water charged ground

- 4.1 A qualified engineer must certify any installation in water charged, unstable or mine subsidence areas, filled ground or a high water table.

5.0 Bedding material

- 5.1 Bedding material to be 1 part Portland cement to 4 parts clean sand
- 5.2 Compact thoroughly by tampering every 300mm.
- 5.3 Encase the whole tank.

6.0 Final Backfill

- 6.1 Spoil from the excavation may be used.
- 6.2 Do not use bricks, concrete or builders waste to backfill

7.0 Covers

- Ensure load rating for the cover is appropriate prior to install.

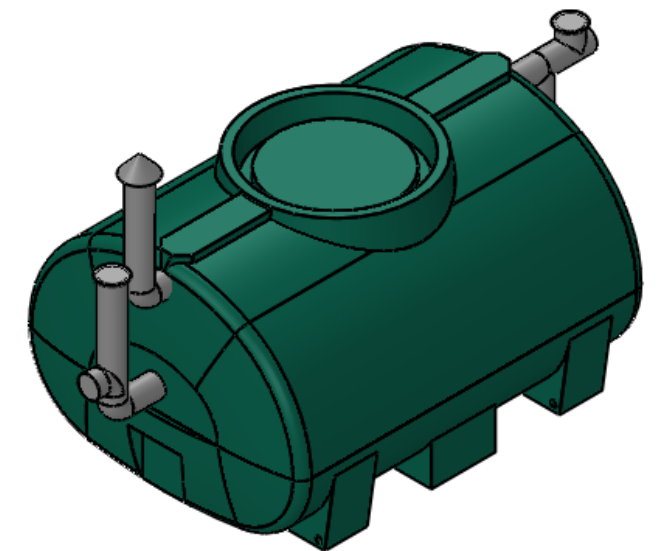

ISOMETRIC VIEW

DO NOT SCALE DRAWING	REVISION: A	MATERIAL: Polyethylene
		PH: 0423 814 556 steve@qsinationalwaste.com.au
TITLE:		
QGT1000 GREASE TRAP		
DWG NO.	A4	
QGT1000-001		
WEIGHT:	SHEET 1 OF 1	SCALE: 1:20